



FITTING INSTRUCTIONS FOR LP0238BK LICENCE PLATE BRACKET
SUZUKI GSX 125 R AND S '17-



THIS KIT CONTAINS THE ITEMS PICTURED AND LABELLED BELOW.
DO NOT PROCEED UNTIL YOU ARE SURE ALL PARTS ARE PRESENT.

Please note that the way the kit is packed does not necessarily represent the way of mounting to the bike.

THE PARTS SHOWN MAY BE REPRESENTATIVE ONLY (FOR CLARITY OF INSTRUCTIONS ONLY).

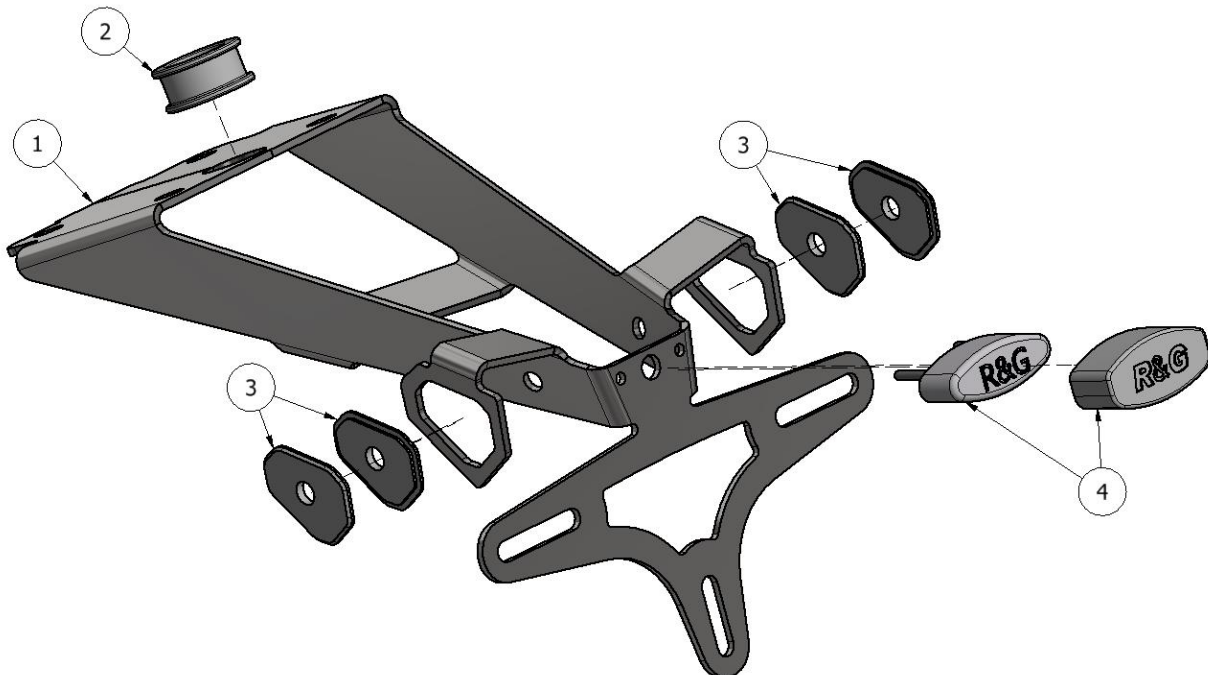

R&G

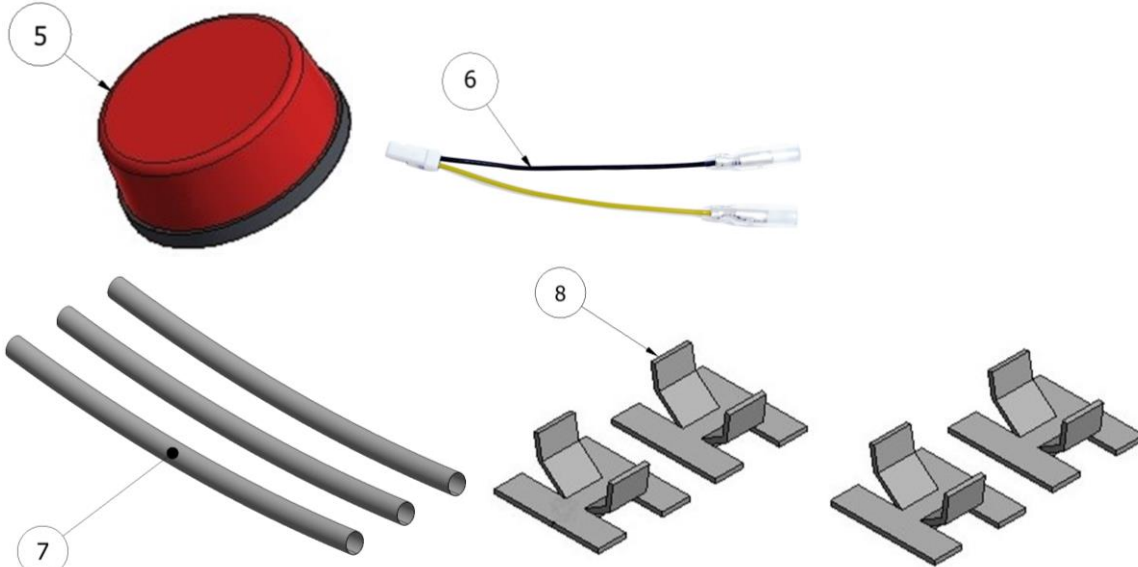

LEGEND

- ITEM 1 = LICENCE PLATE BRACKET (TB0238) (x1).
- ITEM 2 = RB0004 RUBBER GASKET (x1)
- ITEM 3 = I0056 MINI INDICATOR ADAPTOR (x4).
- ITEM 4 = LICENCE PLATE ILLUMINATOR (LA0002) (x1).
- ITEM 5 = REFLECTOR (x1).
- ITEM 6 = LICENCE PLATE ILLUMINATOR CONNECTOR (CON0014) (x1)
- ITEM 7 = 150MM LENGTH OF HEATSHRINK (x3)
- ITEM 8 = CLIP01 SELF-ADHESIVE CABLE CLIPS (x4)

Please note that in cases where kits are packed with rubber washers holding the components onto the bolt – *the rubber washers should be thrown away!*

TOOLS REQUIRED

- Set of metric Allen keys.
- Set of metric sockets and wrench.
 - Phillips screwdriver.

MAXIMUM TORQUE SETTINGS

- M4 Bolt = 8 Nm
- M5 Bolt = 12 Nm
- M6 Bolt = 15 Nm
- M8 Bolt = 20 Nm

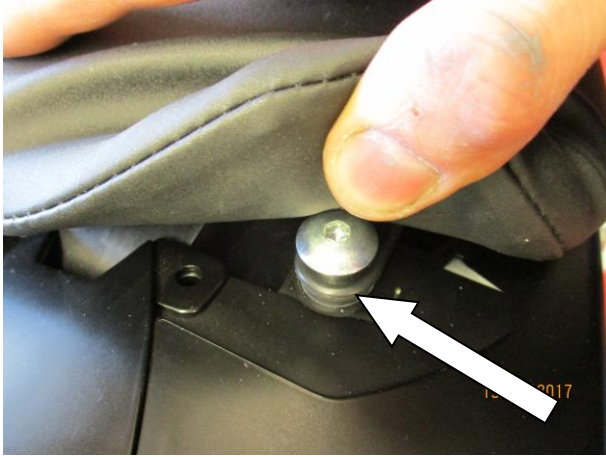

Picture 1

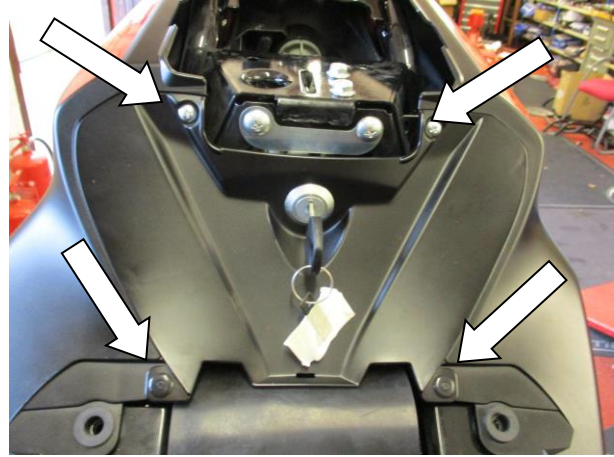

Picture 2

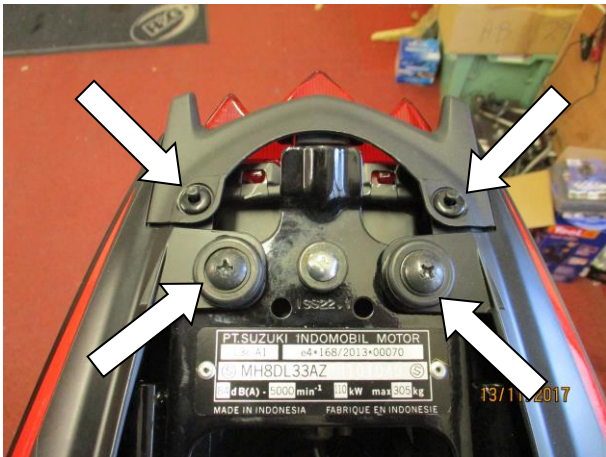

Picture 3



Picture 4



Picture 5

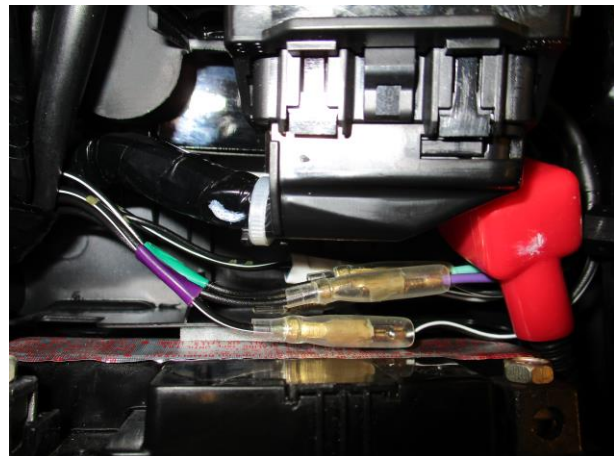

Picture 6



Picture 7



Picture 8



Picture 9

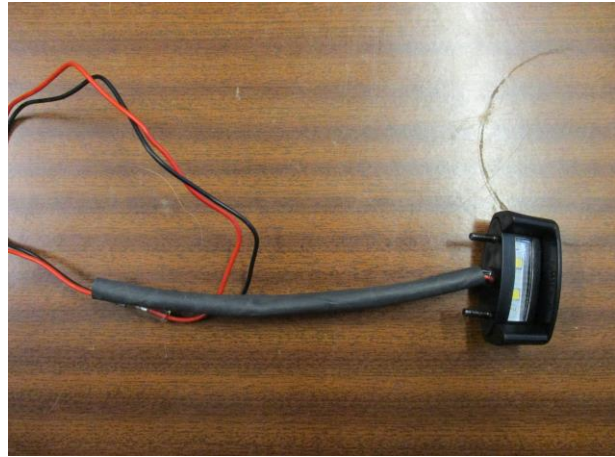

Picture 10

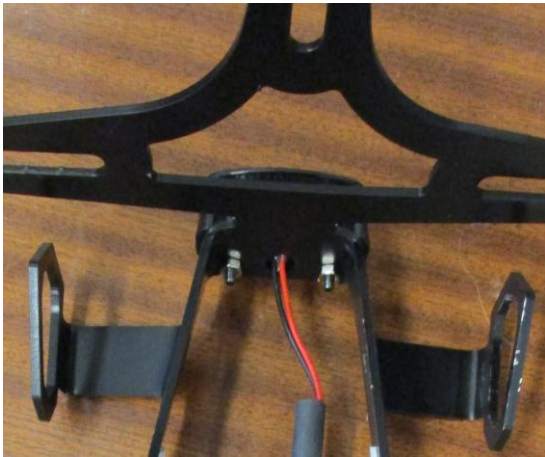

Picture 11



Picture 12

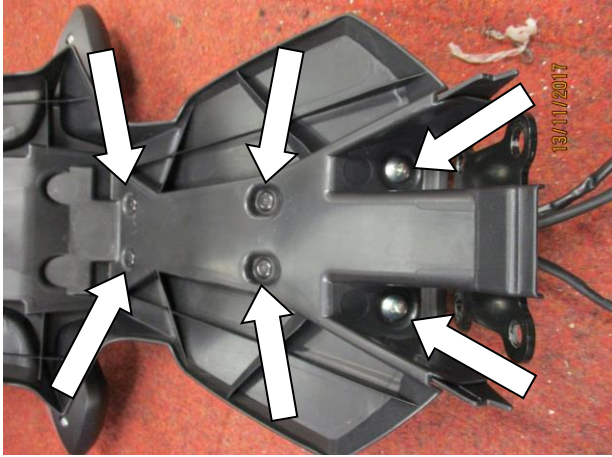

Picture 13



Picture 14



Picture 15



Picture 16

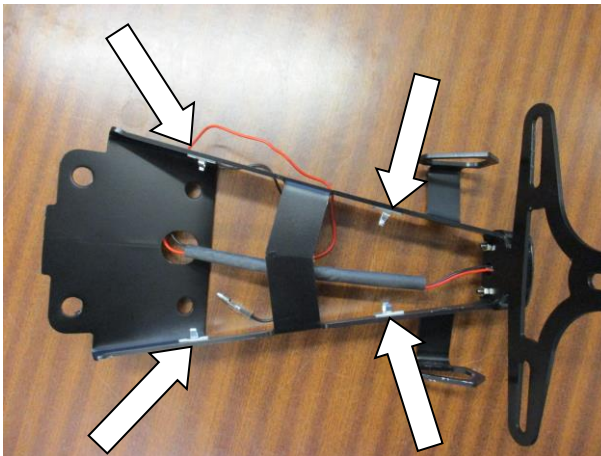

Picture 17



Picture 18

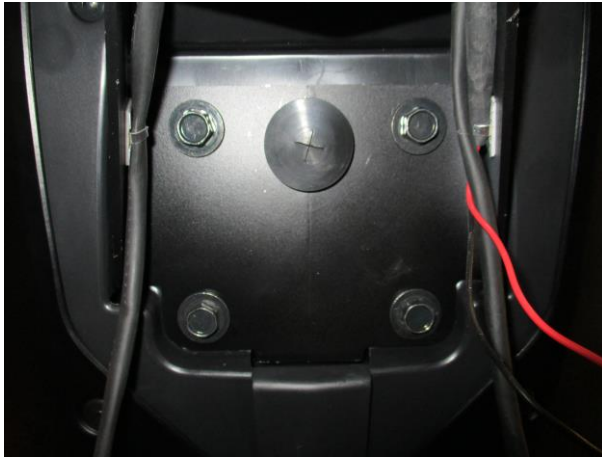

Picture 19

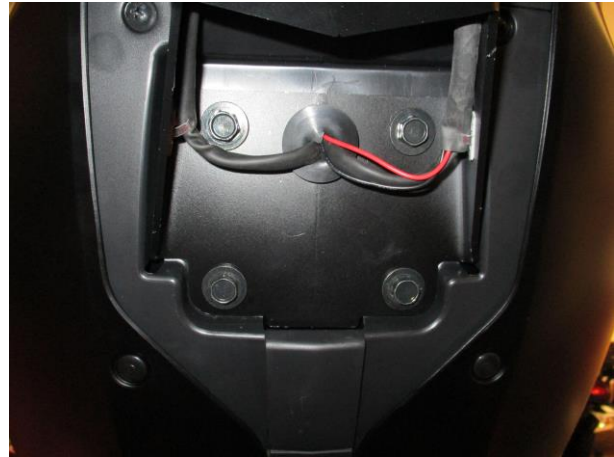

Picture 20

FITTING INSTRUCTIONS

- To fit the R&G tail tidy, remove the pillion seat using the motorcycle key.
- Remove the rider seat by pulling back the corner of the seat and removing the bolts from both sides shown in picture 1.
- Remove the 2 plastic push rivets and 2 screws arrowed in picture 2.
- Remove the 2 plastic push rivets and 2 bolts arrowed in picture 3.
- Remove the panel as shown in picture 4 by gently pulling the 2 rear panels to the side and sliding the panel forwards until the plastic locators disengage and the panel can be removed.
- Pull back the electric connector box shown in picture 5 until the 2 rubber slots on the side disengage and then put the box to the side.
- Disconnect the indicator bullet connectors shown in picture 6 noting the setup of the wiring (there are 2 connectors per indicator).
- Disconnect the licence plate connector shown in picture 7.
- Remove the 4 bolts shown in picture 8 and put to one side to be used again later.
- Pull down on the fender and licence plate assembly to disengage the rubber locator and remove the assembly as shown in picture 9 ensuring the wiring does not snag as it passes through the seat.
- Fit a length of heatshrink (item 7) to the wiring of the licence plate illuminator to protect the exposed wiring of the licence plate illuminator as shown in picture 10.
- Fit the new licence plate illuminator (item 4) to the licence plate bracket (item 1) by passing the wire through the central hole and threads through the corresponding holes, secure using the M3 washers and nuts provided as shown in picture 11.
- Apply a small amount of super glue to the top of the licence plate illuminator and slide the shroud over the top of it.
- Fit the licence plate illuminator connector (item 6) to the licence plate illuminator wiring following this scheme:
Illuminator RED-----→Illuminator connector BLACK
Illuminator BLACK---→Illuminator connector YELLOW

If fitting OEM indicators

- From the OEM fender remove the 3 screws shown in picture 12 and the 4 push rivets and 2 screws shown in picture 13.
- Pull the plastic locking key from the indicator as shown in picture 14 and remove the indicator by pulling the wire through the tube and popping the indicator out of the slot.

R&G

Unit 1, Shelley's Lane, East Worldham, Alton, Hampshire, GU34 3AQ

Tel: +44 (0)1420 89007 Fax: +44 (0)1420 87301 www.rg-racing.com Email: info@rg-racing.com



- Refit the OEM indicators to the licence plate bracket (part 1) using the slots on the side in the same way as the OEM part and refit the plastic locking key.
- Use the 4 self-adhesive cable clips (item 8) in the locations shown in picture 17.
- Neatly route the wiring using the cable clips as shown in picture 18.
- Using the 4 OEM bolts removed earlier, mount the licence plate bracket as shown in picture 19.
- Fit the rubber gasket (item 2) into the wiring hole as shown in picture 19 and thread the wiring through the gasket as shown in picture 20.
- Connect the OEM indicator wiring in the same way it was removed:
 - LHS Indicator (marked on motorcycle loom with purple insulation tape):
 - Motorcycle loom BLACK-----→OEM indicator PURPLE
 - Motorcycle loom BLACK/WHITE-→OEM indicator BLACK/WHITE
 - RHS Indicator (marked on motorcycle wiring with green insulation tape)
 - Motorcycle loom BLACK-----→OEM indicator GREEN
 - Motorcycle loom BLACK/WHITE-→OEM indicator BLACK/WHITE
- Test the indicators and licence plate illuminator for correct function and flash rate.
- If indicators fail to illuminate swap the connectors.

If fitting R&G mini indicators-Not included (Product codes: RG370=Bulb, RG371=LED, RG372=Aero LED)

- Pass one length of heatshrink (item 7) over the wiring on both mini indicators as shown in picture 15.
- Take 2 mini indicator adaptors (item 3) and place them either side of the indicator mount on the licence plate bracket part 1 (item 1) ensuring that the locators secure into the slot on the licence plate bracket as shown in picture 16.
- Pass the R&G mini indicator through the holes in the indicator adaptors and use the flange nut supplied with the indicator to hold it in place as shown in picture 16.
- Ensure the indicator wiring passes through the hole into the licence plate bracket.
- Repeat this process for both indicators.
- Use the 4 self-adhesive cable clips (item 8) in the locations shown in picture 17.
- Neatly route the wiring using the cable clips as shown in picture 18.
- Using the 4 OEM bolts removed earlier, mount the licence plate bracket as shown in picture 19.
- Fit the rubber gasket (item 2) into the wiring hole as shown in picture 19 and thread the wiring through the gasket as shown in picture 20.
- If only fitting mini indicators to the rear of the motorcycle and leaving the OEM indicators on the front connect the indicator wiring to a resistor (R&G product code: RGR0001) and connect this to the motorcycle loom following this scheme:
 - LHS Indicator (marked on motorcycle loom with purple insulation tape):
 - Motorcycle loom BLACK→Resistor (RGR0001) YELLOW→R&G mini indicator YELLOW
 - Motorcycle loom BLACK/WHITE→Resistor (RGR0001) BLACK→R&G mini indicator BLACK
 - RHS Indicator (marked on motorcycle wiring with green insulation tape)
 - Motorcycle loom BLACK→Resistor (RGR0001) YELLOW→R&G mini indicator YELLOW
 - Motorcycle loom BLACK/WHITE→Resistor (RGR0001) BLACK→R&G mini indicator BLACK
- Test the indicators and licence plate illuminator for correct function and flash rate.
- If indicators fail to illuminate swap the connectors.
- If fitting R&G mini indicators to the front of the motorcycle replace the rear resistor (RGR0001) with (RGR0002) and use resistor (RGR0001) for the front indicators.
- Refit the seat panel, rider seat and pillion seat in the same way they were removed.

ISSUE 2 16/01/2018 (HB)

R&G

Unit 1, Shelley's Lane, East Worldham, Alton, Hampshire, GU34 3AQ
Tel: +44 (0)1420 89007 Fax: +44 (0)1420 87301 www.rg-racing.com Email: info@rg-racing.com



Digital copies of these instructions are available to download from www.rg-racing.com

CONSUMER NOTICE

The catalogue description and any exhibition of samples are only broad indications of the Products and R&G may make design changes which do not diminish their performance or visual appeal and supplying them in such state shall conform to the order. The Buyer acknowledges no representation or warranty (other than as to title) has been given or will apply to the Products other than those in R&G's order or confirmation and the Buyer confirms it has chosen the Products as being of merchantable quality and suitable for its particular purposes. Where R&G fits the Products or undertakes other services it shall exercise reasonable skill and care and rectify any fault free of charge unless the workmanship has been disturbed. The Buyer is responsible for ensuring that the warranty on the motorcycle is not affected by the fitting of the Products. On return of any defective Products R&G shall at its option either supply a replacement or refund the purchase money but shall not be liable if the Products have been modified or used or maintained otherwise than in accordance with R&G's or manufacturer's instructions and good engineering practice or if the defect arises from accident or neglect. Other than identified above and subject to R&G not limiting its liability for causing death and personal injury, it shall not be liable for indirect or consequential loss and otherwise its liability shall be limited to the amounts paid by the Buyer for the Products or the fitting or service concerned. These terms do not affect the Buyer's statutory rights.

Page | 8

R&G RETURNS POLICY (NON-FAULTY GOODS)

Returns must be pre-authorized (if not pre-authorized the return will be rejected). Goods may only be returned direct to us if they were purchased direct from us (customer must prove if necessary). Otherwise to be returned to original vendor. Goods must be in re-sellable condition, in the opinion of R&G. All returns are subject to a 25% restocking and handling fee (25% of the gross value exc. P&P – at the prevailing price at time of purchase). The customer must pay any and all carriage charges. No returns of discontinued products, unless within 14 days of purchase. This policy does not affect your statutory rights and does not refer to faulty goods.

R&G

Unit 1, Shelley's Lane, East Worldham, Alton, Hampshire, GU34 3AQ

Tel: +44 (0)1420 89007 Fax: +44 (0)1420 87301 www.rg-racing.com Email: info@rg-racing.com



NOTICE DE MONTAGE POUR LP0238BK SUPPORT DE PLAQUE
SUZUKI GSX 125 R AND S '17-

Page | 9



Le kit contient les articles exposés ci-dessous, vérifier que toutes les pièces soient présentes avant de procéder au montage.

La façon dont le kit est emballé ne correspond pas forcément à la façon de monter les pièces sur la moto.

LES PARTIES PRESENTEES PEUVENT ETRE UNIQUEMENT REPRESENTATIVES (POUR LA CLARTE DES INSTRUCTIONS UNIQUEMENT).

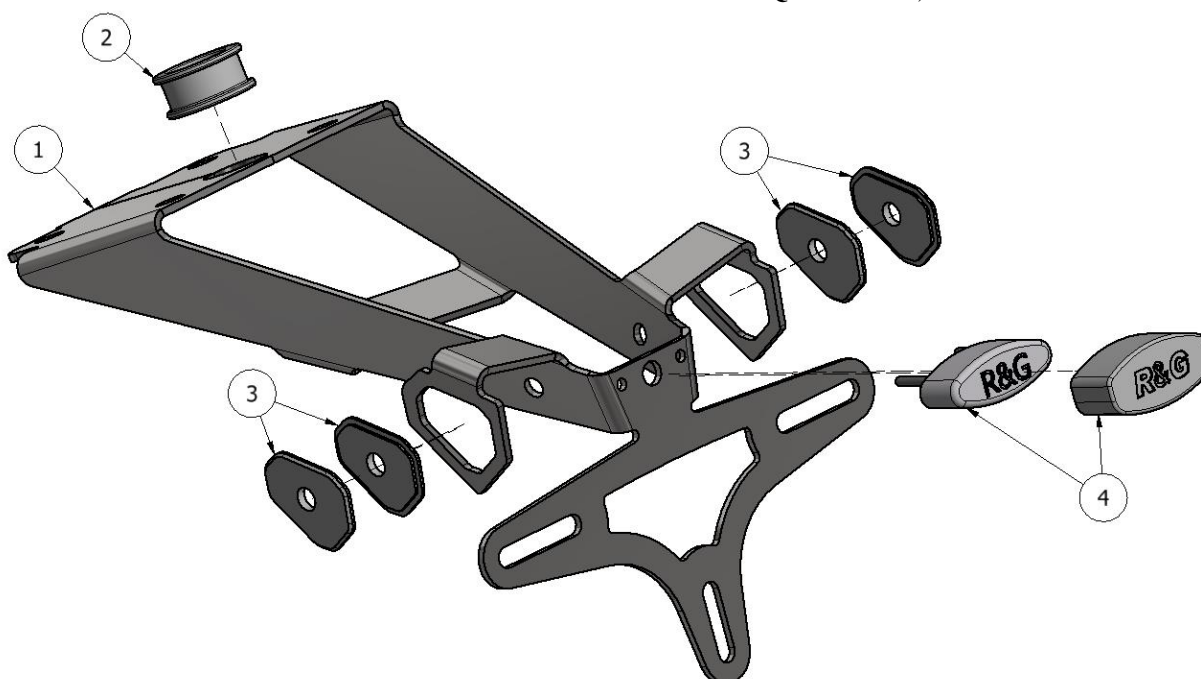

R&G

Unit 1, Shelley's Lane, East Worldham, Alton, Hampshire, GU34 3AQ
Tel: +44 (0)1420 89007 Fax: +44 (0)1420 87301 www.rg-racing.com Email: info@rg-racing.com

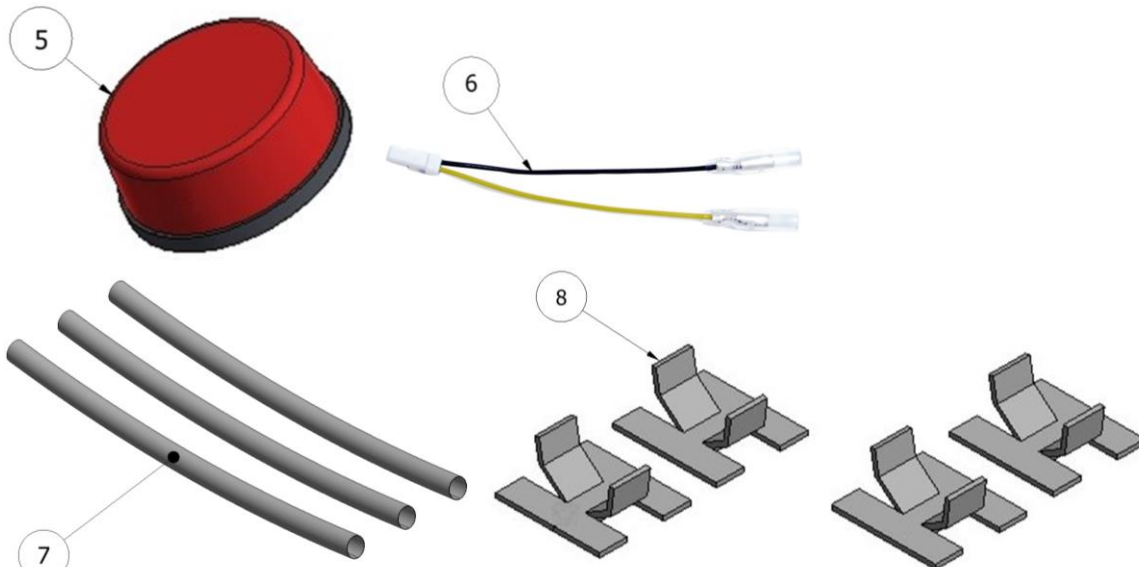

LÉGENDE

- ARTICLE 1 = SUPPORT DE PLAQUE (TB0238) (x1).
- ARTICLE 2 = RB0004 JOINT EN CAOUTCHOUC (x1)
- ARTICLE 3 = I0056 ADAPTATEUR DE MINI CLIGNOTANT (x4).
- ARTICLE 4 = FEU DE PLAQUE (LA0002) (x1).
- ARTICLE 5 = RÉFLECTEUR (x1).
- ARTICLE 6 = CONNECTEUR DE FEU DE PLAQUE (CON0014) (x1)
- ARTICLE 7 = 150MM LONGUEUR DE MANCHON THERMO RÉTRACTABLE (x3)
- ARTICLE 8 = CLIP01 CLIPS AUTOCOLLANTSCLIPS (x4)

Notez que si les kits sont emballés avec des rondelles en caoutchouc servant à tenir les composants, *ces rondelles doivent être jetées !*

OUTILS REQUIS

- Clés Allen.
- Clés à cliquet + douilles.
- Tournevis cruciforme.

VALEURS DE SERRAGE

- M4 BOULON = 8 Nm
- M5 BOULON = 12Nm
- M6 BOULON = 15Nm
- M8 BOULON = 20 Nm

NOTICE DE MONTAGE

- Enlever le siège passager à l'aide de la clé de la moto.
- Enlever le siège du pilote en tirant le coin inférieur du siège et en enlevant les boulons des 2 côtés, voir photo 1.

R&G



- Enlever les 2 rivets et les 2 vis indiquées sur la photo 2.
- Enlever les 2 rivets et les 2 boulons indiqués sur la photo 3.
- Enlever le panneau, comme sur la photo 4 en tirant délicatement les 2 panneaux arrière sur le côté et en glissant le panneau vers l'avant jusqu'à ce que les onglets en plastique soient libérés et que le panneau puisse être enlevé.
- Tirer le boîtier de connecteurs électrique indiquée sur la photo 5 jusqu'à ce que les 2 fentes en caoutchouc sur le côté soient libérées puis mettre le boîtier sur le côté.
- Déconnecter les connecteurs de clignotants indiqués sur la photo 6 en notant la configuration des fils (Il y a 2 connecteurs par clignotant).
- Déconnecter le connecteur de feu de plaque, voir photo 7.
- Enlever les 4 boulons indiqués sur la photo 8 et mettez-les de côté pour pouvoir les réutiliser plus tard.
- Tirer vers le bas l'aile et l'assemblage de feu de plaque pour libérer le caoutchouc puis enlever l'assemblage comme sur la photo 9 en veillant à ce que le fil ne soit pas pincé lorsqu'il passe à travers le siège.
- Appliquer une longueur de manchon thermos rétractable (article 7) sur le fil du feu de plaque afin de le protéger, voir photo 10.
- Monter le nouveau feu de plaque (article 4) sur le support de plaque (article 1) en passant le fil dans le trou central et les filetages dans les trous correspondant, avant de fixer à l'aide des rondelles M3 et écrous fournis, voir photo 11.
- Appliquer un peu de superglue sur le haut du feu de plaque puis glisser le linceul sur le haut de celui-ci.
- Appliquer une longueur de thermo rétractable (article 7) sur le fil du feu de plaque pour protéger le fil.
- Monter le connecteur de feu de plaque (article 6) sur le fil de feu de plaque, selon ce schéma :
Feu ROUGE-----→ Connecteur de feu r BLACK
Feu NOIR---→ Connecteur de feu JAUNE
- Passer le fil dans le trou indiqué, voir photo 10 puis remonter le nouveau connecteur de feu sur le faisceau de la moto.

Si vous montez les clignotants d'origine

- Enlever les 3 vis de l'aile d'origine, voir photo 12 et les 4 rivets et 2 vis indiqués sur la photo 13.
- Tirez la clé de verrouillage en plastique du clignotant, voir photo 14 puis enlever le clignotants en tirant le fil à travers le tube et la fente.
- Remonter les clignotants d'origine sur le support de plaque (partie 1) en utilisant les fentes sur le côté de la même façon que la partie d'origine puis remonter la serrure en plastique.
- Utilisez les 4 serre-câbles autocollants (article 8) aux emplacements indiqués sur la photo 17/17.
- Acheminez soigneusement le câblage en utilisant les serre-câbles comme indiqué sur la photo 18.
- À l'aide des 4 boulons d'origine retirés précédemment, montez le support de la plaque d'immatriculation comme indiqué sur la photo 19.
- Installez le joint en caoutchouc (article 2) dans le trou de câblage comme indiqué sur la photo 19 et faites passer le câblage à travers le joint comme indiqué sur la photo 20.
- Connectez le câblage du clignotant d'origine de la même manière qu'il a été retiré :
Faisceau de la moto NOIR-----→ Clignotant d'origine VIOLET
Faisceau de la moto NOIR/BLANC-→ Clignotant d'origine NOIR/BLANC
Clignotant DROIT (marqué sur le faisceau de la moto avec un ruban vert)
Faisceau de la moto NOIR -----→ Clignotant d'origine VERT
Faisceau de la moto NOIR/BLANC-→ Clignotant d'origine NOIR/BLANC
- Tester les clignotants et le feu de plaque pour vérifier le fonctionnement et le niveau d'éclairage.
- Si les clignotants ne s'allument pas, tournez les connecteurs.

R&G

Unit 1, Shelley's Lane, East Worldham, Alton, Hampshire, GU34 3AQ

Tel: +44 (0)1420 89007 Fax: +44 (0)1420 87301 www.rg-racing.com Email: info@rg-racing.com



Si vous montez les mini clignotants R&G - Non inclus (Codes produit : RG370=Ampoule, RG371=LED, RG372=LED latérale)

- Passez une longueur de gaine thermo rétractable (article 7) sur le câblage des deux mini-clignotants, comme indiqué sur la photo 15.
- Prenez deux adaptateurs de mini-clignotants (article 3) et placez-les des deux côtés du support de clignotant sur la partie du support de plaque d'immatriculation 1 (article 1) en vous assurant qu'ils sont bien fixés dans l'emplacement de la plaque d'immatriculation, voir photo 16.
- Faites passer les mini-clignotants R & G à travers les trous des adaptateurs de clignotant et utilisez l'écrou à bride fourni avec le clignotant pour le maintenir en place comme indiqué sur la photo 16.
- Assurez-vous que le câblage du clignotant traverse le trou dans le support de la plaque d'immatriculation.
- Répétez ce processus pour les deux clignotants.
- Utilisez les 4 serre-câbles autocollants (article 8) aux emplacements indiqués sur la photo 17.
- Acheminez soigneusement le câblage en utilisant les serre-câbles comme indiqué sur la photo 18.
- À l'aide des 4 boulons OEM retirés précédemment, montez le support de la plaque d'immatriculation comme indiqué sur la photo 19.
- Installez le joint en caoutchouc (article 2) dans le trou de câblage comme indiqué sur la photo 19 et faites passer le câblage à travers le joint comme indiqué sur la photo 20.
- Si vous montez les mini clignotants sur l'arrière de la moto et laissez les clignotants d'origine sur l'avant, connecter le fil de clignotant à une résistance (code produit R&G : RGR0001) puis connectez-le au faisceau de la moto selon ce schéma :

Clignotant GAUCHE (marqué sur le faisceau de la moto par un ruban violet):

Faisceau de la moto NOIR → Résistance (RGR0001) JAUNE → Mini clignotant R&G JAUNE

Faisceau de la moto NOIR /BLANC → Résistance (RGR0001) NOIR → Mini clignotant R&G NOIR

Clignotant DROIT (marqué sur le faisceau de la moto avec un ruban vert)

Faisceau de la moto NOIR → Résistance (RGR0001) JAUNE → Mini clignotant R&G JAUNE

Faisceau de la moto NOIR/BLANC → Résistance (RGR0001) BLACK → Mini clignotant R&G NOIR

Clignotant GAUCHE (marqué sur le faisceau de la moto avec un ruban violet) :

Faisceau de la moto NOIR-----→ Clignotant d'origine VIOLET

Faisceau de la moto NOIR/BLANC-→ Clignotant d'origine NOIR/BLANC

Clignotant DROIT (marqué sur le faisceau de la moto avec un ruban vert)

Faisceau de la moto NOIR -----→ Clignotant d'origine VERT

Faisceau de la moto NOIR/BLANC-→ Clignotant d'origine NOIR/BLANC

- Tester les clignotants et le feu de plaque pour vérifier le fonctionnement et le niveau d'éclairage.
- Si les clignotants ne fonctionnent pas, tournez les connecteurs.
- Si vous installez les mini clignotants R&G à l'avant de la moto, remplacez la résistance arrière (RGR0001) par (RGR0002) et utilisez la résistance (RGR0001) pour les clignotants avant.
- Utiliser les 2 boulons restant (photo 8) pour monter le support de plaque partie 2 (article 2) voir photo 16 en veillant à ce que le clignotant et le fil de feu de plaque se retrouvent dans la chaîne du support de plaque.
- Utiliser 2 boulons M5 (article 4) pour monter le support de plaque partie 1 (article 1) sur l'avant du support de plaque 2 (article 2) voir photo 17.
- Remonter le panneau de siège, le siège du pilote et le siège passager de la même façon qu'ils ont été enlevés.

ISSUE 2 16/01/2018 (HB)

R&G

Unit 1, Shelley's Lane, East Worldham, Alton, Hampshire, GU34 3AQ

Tel: +44 (0)1420 89007 Fax: +44 (0)1420 87301 www.rg-racing.com Email: info@rg-racing.com



Notice disponible au téléchargement sur www.rg-racing.com

CONSUMER NOTICE

The catalogue description and any exhibition of samples are only broad indications of the Products and R&G may make design changes which do not diminish their performance or visual appeal and supplying them in such state shall conform to the order. The Buyer acknowledges no representation or warranty (other than as to title) has been given or will apply to the Products other than those in R&G's order or confirmation and the Buyer confirms it has chosen the Products as being of merchantable quality and suitable for its particular purposes. Where R&G fits the Products or undertakes other services it shall exercise reasonable skill and care and rectify any fault free of charge unless the workmanship has been disturbed. The Buyer is responsible for ensuring that the warranty on the motorcycle is not affected by the fitting of the Products. On return of any defective Products R&G shall at its option either supply a replacement or refund the purchase money but shall not be liable if the Products have been modified or used or maintained otherwise than in accordance with R&G's or manufacturer's instructions and good engineering practice or if the defect arises from accident or neglect. Other than identified above and subject to R&G not limiting its liability for causing death and personal injury, it shall not be liable for indirect or consequential loss and otherwise its liability shall be limited to the amounts paid by the Buyer for the Products or the fitting or service concerned. These terms do not affect the Buyer's statutory rights.

R&G RETURNS POLICY (NON-FAULTY GOODS)

Returns must be pre-authorised (if not pre-authorised the return will be rejected). Goods may only be returned direct to us if they were purchased direct from us (customer must prove if necessary). Otherwise to be returned to original vendor. Goods must be in re-sellable condition, in the opinion of R&G. All returns are subject to a 25% restocking and handling fee (25% of the gross value exc. P&P – at the prevailing price at time of purchase). The customer must pay any and all carriage charges. No returns of discontinued products, unless within 14 days of purchase. This policy does not affect your statutory rights and does not refer to faulty goods.